



A
JOURNEY
TO OUTER
SPACE

THE SPACE KID

j.m diniru sithmira |

Preface

The primary goal of the current educational system is to mould a productive citizen and a caring family member who is equipped with knowledge and skills. The main responsibility of the school is to identify and recognize children's talents, as well as to sharpen their skills to meet the needs of the nation and the world.

Our Alma Mater is constantly guiding and assisting children who are creative. This project has been an ongoing process at our school for many years, particularly in terms of writing books. Many skilled and enthusiastic young writers participated in this exercise for years, producing novice writers to field of literature. We regard this as a great victory and a national need at this hour.

To continue this effort, we have adopted digital technologies and an e-book project this year. I am confident that this unique event provided youngsters with valuable experience and challenges that will benefit them in the future.

The Ministry of Education has hailed the project as an important step toward motivating young authors in schools. As principal of Mahamaya Girls' College, I am grateful to all of the students throughout the country who contributed to this endeavor. I commend and applaud all of the young authors of these-books for their perseverance and devotion in this difficult task.

I would like to thank our school management committee, employees, parents, for my students, administrators, and teachers from other schools who encouraged students to take part in this worthwhile effort.

Ms Shashikala Senadheera
Principal
Mahamaya Girls College – kandy

2023 . 11 . 10

Contents

1. chapter1	1
2. chapter2	7
3 .chapter3	10
4. chapter4	12
5. chapter5	13
6. chapter6	17
7. chapter7	19
8. chapter8	20
9. chapter9	21
10. chapter10	23
11. chapter11	26
12. chapter12	30
13. chapter13	34
14. chapter14	38
15. chapter15	41
16. chapter16	43
17. chapter17	45

Introduction

It's a new day in New York City. Lucas is looking at the beautiful city from the window. He is 12 years old. He is a kid who liked to learn about space. He had made a telescope with things that won't be needed. He often looks at the planet Mars with it. He believes that the aliens are alive. He shows his mother some things that look similar to humans in photos that had been founded on the web. Yes, his mother always blames him and says to do his homework. His brother will laugh at him whenever he is looking at the sky with that telescope. But, he doesn't give up on trying finding something that would amaze the whole wide world. His main target is finding aliens. He reads newspapers and books about space missions, findings of aliens, and aliens visiting the planet Earth; he just won't get enough of it. Sometimes his friends visit him and enjoy finding things about aliens. It is a very good help for him. He also likes to visit the park in his free time or when he is in a bad mood. Well, the story tells that one day he will find an amazing something that would amaze the whole wide world.

Chapter 1

The alarm is ringing. Lucas wakes up at 7.00 am. He yawns and gets off his bed and washes his face and gets ready for the day. His mother wakes up way before Lucas. She wakes up early and prepares Lucas lunch and breakfast too. Lucas goes to a school in his city. So, yeah his mother won't have taken him to go very far to get him to school. It is

easy for her. His father is not in their city. He is in another city very far from them. Lucas hasn't seen his father for almost 5 years. Lucas was very sad from the day he was leaving their home. He calls his father twice a day. But, he needs to see him for real. So, he is only happy when he is doing his hobby, searching for things about aliens. He sometimes wonders if he had an alien friend, what to do. Well, he thinks about going to outer space with him, walking on the moon with him, going to their planet. He could think about it for a day. He goes to school early. That makes him happy. He disguises things with his friends that he had find about aliens. Sometimes teachers blame him for chatting in class when the teacher is teaching a lesson. He only doesn't love things about aliens; he loves His school time too. It's really fun for him. He has a bunch of friends in his classroom. His best friends are Joe, Nick, and Crisp. They help him whenever Lucas is in trouble or when he needs help. Lucas also helps them.

"Lucas, Lucas" his mother is calling out for him. By the way, he is home today; yeah he didn't go to school. About one thing I forget to tell you about is, in a day he wouldn't go to school, his day is all about reading books about aliens. He is crazy about aliens. Not to mention that he even built a machine that would detect the signals coming from outer space.

"Yes Mother, did you call me? I am middle of reading a book!" his mother always knows that he would tell the same answer as this, every time. The days went off just the way it is until December arrives.

Everyone loves Christmas. It was the time that Santa Claus would come, sharing presents. Everyone loves it. And Lucas loves it too. But this time, he was in another thing.

I told you about the machine he made, right? The one that could detect signals from outer space, and guess what he received a signal from it. It was from outer space. As I know, you would probably think it was a signal from a space station, Lucas too. But when he translated the signal, it was a whole other story.

It was a signal that came from a distant planet called "Kesus 22-b". And there he goes. He went wild. And the message said "Captain Tim sir, we have discovered a planet called Earth. And it is fulfilled with the rarest object in the galaxy. Water; we can use this object to power our machine. As per our calculations sir, it's the only thing powerful enough to power our machine, sir, as soon we'll get the object and powers our machine, we're going to conquer the whole galaxy sir, and we'll be waiting at the planet Earth. As on the city called "New York" sir, over" that. And you know the city where Lucas lives. Of course, it's New York.

Lucas rushed in a hurry, to tell her mother about the signal, he felt very proud. But as soon as he told her mother about the signal, Lucas was very

Sad, she said, "Oh Lucas, don't be silly. There is no such thing as aliens".

But Lucas never gives up, he had the exact location where the signal said, so all was left to wait and watch.

Lucas thought the aliens might show up and night. And he thought they might show up in a park, forest something like that. So, he went to the central park, Hid near a bush. He waited and waited. Sooner came the night time. But there was no sign of an alien. He brought his signal-picking device too. Just in case. But he waited and waited. Sooner the clock hit midnight, But there still was no sign of any alien But just when

he was about to give up, the device picked up a signal. He translated it, and he was shocked. The aliens were there, they were invisible. So in a hurry, he repaired the device to pick up what they were talking about. They were talking about how to get the water. The discussion ended soon. And a bright white light appeared in the sky. It was an alien ship. He felt like gravity was weak. He held on to the bush. But along with the bush he floated up to the alien ship.

Chapter 2

For a minute he remembered nothing. And then he slightly remembered everything bit by bit. And then he opened his eyes. He saw a bright light.

And then the lights were gone. He woke up. He thought he saw a weird nightmare, but then started to look around. Everything was bright white.

And greeny things were controlling the ship. He looked outside the window. And he was shocked. He was in space, with aliens. And then some aliens gathered around him. They were speaking another language.

He translated it. It said, " This earth creature has sneaked into the ship when we were on planet Earth talking about the discussion." Lucas tried to speak to them with his device. Several attempts failed. But finally, he was able to get the device up and running.

He was afraid that the aliens might harm him. But turns out, they are harmless. He took his device and said “where are you taking me”. And they said “you have been sneaked in to our ship”. Lucas was very confused. He was in space. No way to get back home. His mom should be panicking at home now. He asked the aliens where they are going. And they said they were going to their home planet. And what’s there home planet? It’s the planet “kesus22-b”. Lucas was shocked. The signal he received from that planet. And that’s their home planet.

Two days passed, Lucas was worried. He tried to communicate with his mom. But the aliens won’t let him, because, they might noticed that there were aliens out there in the universe. Lucas wondered if there planet was some kind of a planet like earth. He was exciting and also afraid. At the first time he was worried that the aliens might harm him. But they did not. So he was a little afraid.

Quite some days passed, Lucas now used to what the aliens are eating. They were some kind of leaves. If you’re asking that are they tasty, the answer is no. he was in a cage, with no way to get out. But the cage had a bed chair. It’s called a bed chair because, it looks like a bed and at the

same time it looks like a chair. You'll get the picture.

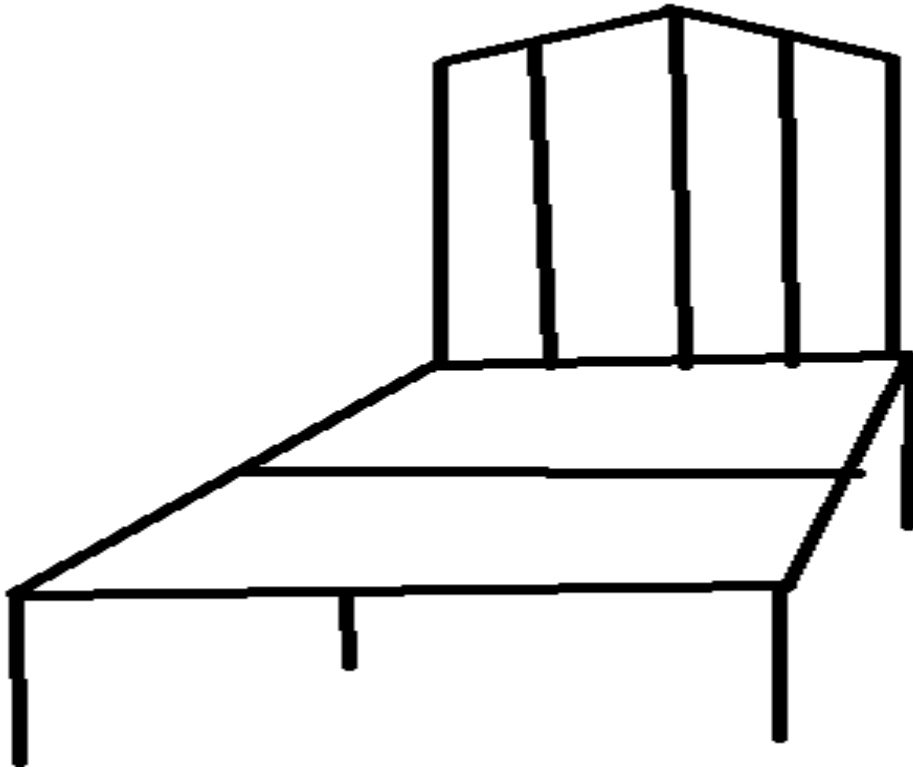

Lucas was wandering about his parents. He was sad. He wanted to go home. But just on that minute an alarm ring. They were about to enter an atmosphere of a planet. Lucas was surprised. Now they have landed on the planet. The doors opened. Lucas was shocked. It just looks like his planet. They took him to their leader.

The leader lived in the central of the planet. The planet was twice times bigger than his planet. They took him to the building the leader lived.

Chapter 3

There must've been like 32 floors. It's a tall building. Lucas thought it's the end of his life. Finally, they reached the 50 Th floor. Yeah, there were 50 floors. The leader was scary, wears black glasses and very-very-very small really. And on top of his head there was some kind of a circuit. Lucas thought it was his crown. The aliens spoke in another language. He thought he might be killed. After some moments the leader spoke, Lucas translated it; it said he was free to live in this planet. Lucas was very happy.

The aliens send Lucas to the middle of the alien city. It was a park. Lucas sat in bench; he thought about his mother, he was very unhappy. But, he had nothing to do about it. He found some wood on the park and built a little shop to earn some money. Well, the only thing he had to sell was wood. So that shop was useless. He went to a shop and asked if he will be able to get some food to eat. And the alien shopkeeper said everything was free. He was shocked. He brought some apples like thing to eat. And that apple like things had a really weird name. Its name was booknut. Lucas wondered if that thing was made out of books. Well, it did taste like books. After that he went to explore this world a bit more.

Several days like this passed away. Lucas was lonely because his mother wasn't there. But it all changed on the day he went to get some food from the market. As usual he ate the foods and threw them in the trash can. But when he threw the trash in the trash can the trash flew back on to him. He looked at the trash can, and there was an alien puppy there. He took it where he lived, the alien park.

The puppy can talk actually. So Lucas was not very lonely now. Lucas was very sad since he came to this alien planet. There aren't any playgrounds, no schools, and his mother is not with him. Days like this passed away. Lucas wondered what could be going on in his planet earth. He spends most of his time talking with the alien puppy. He even wondered building a ship and getting out of this planet. Yes, this planet was horrible for Lucas. It was no fun for Lucas at all. The only thing that was good for Lucas was the market and the puppy.

The aliens had hi-tech machines and stuff. They are most like a future version of humans, Yeah, no kidding. They eat food like us, they drink water like us, and most importantly they breathe oxygen. If they weren't breath oxygen, Lucas would be pretty much dead as soon as he arrives. The planet was rich with oxygen. But, there was minor problem with water. Lucas was pretty sure that's why they brought water from earth. There were other creatures too, as bugs, dogs, birds. But they were bigger. These creatures were friends to Lucas. Lucas sleeps in his very own room. They had rooms for everyone. But these weren't able to cheer Lucas up. He thought about going home all the time. He was all alone in that planet with his puppy.

Chapter 4

Things weren't pretty good back out there in earth. There was panic. Luca's mother was panicking; Because Lucas weren't back at home. The police was looking all over for him. But, they couldn't find a single trace of him. He has been disappeared without a trace.

They send signals all over. But there still weren't any sign of him. His friends were talking about him. The world was on Lucas.

Lucas was sleeping in his planet. He still had his device. He thought he'd never get out of this planet. But, just that moment a signal picked up. He was shocked. He is finally communicating with his mother planet earth. Well, he can only read messages. They are all over the world looking for him. It has been a massive shocked to the world. Of course, if he got back home, nobody would believe him. But it was fine with him. He just wanted to get back home. He could be famous for his instant disappearing. But none of this came to his mind. He just wanted to get back home. He talks about this with his puppy all the time. Lucas was very lucky to find it. If it weren't there he probably won't be able to survive.

At the day he received a signal from earth. He thought about leaving this planet and going home. He needed to get out of this planet. But for that he needed to make a ship. For that he needs to get the things that he will be needed to make the ship. And the most needed part was top of the alien leader. Would he take this risk to get back home? He'd need to choose wisely. If not, he could be stuck on that planet forever.

Lucas was in a very big problem. But, he takes that risk. He really wanted to go home. There aren't any schools or anything like that on that planet. When he first arrives he thought he could be happy here for some time and he would be send to earth again over night. But a whole another thing happened. Now he's trapped in this planet, he has only one device. Could that device make a ship? He'll need other parts too. The alien's space ships can't be used because; they would be tracking on the ship. The only way to get out of this planet is to build a ship. There isn't any other way.

Back at home his mother was worried, that they will never find her kid. It's been 1 day since Lucas magically disappears. Yes, one day on earth equals

To ten days on the alien planet. But, that doesn't matter. Lucas thought he would be in some serious trouble when he gets back home. He didn't know when he will get back home and it's all ready been 10 days. He didn't know 10 days up on that planet means 1 day on earth. But he thought about not wasting time thinking, it would be the perfect time to start building the ship.

Chapter 5

They began with the plan. There were mainly four parts. The first is the glass window, the second was the steering wheel, the third was the engine and the last was the hardest one to get, the circuit. That is on top of the leader of the aliens. Their journey around the city began with the glass factory. Lucas and his puppy went there on an alien car. Lucas

owned that car. Everything was free on this planet. So that wasn't really a problem. Lucas was so lucky that he knew how to drive. It took about 5 minutes to get there. They thought it would be a smoking, spooky, haunted like place. But, it wasn't that bad when they arrived there. It looked like a diamond. And the factory was inside the diamond. And at the top of the diamond there was a long big pipe, which let smoke out

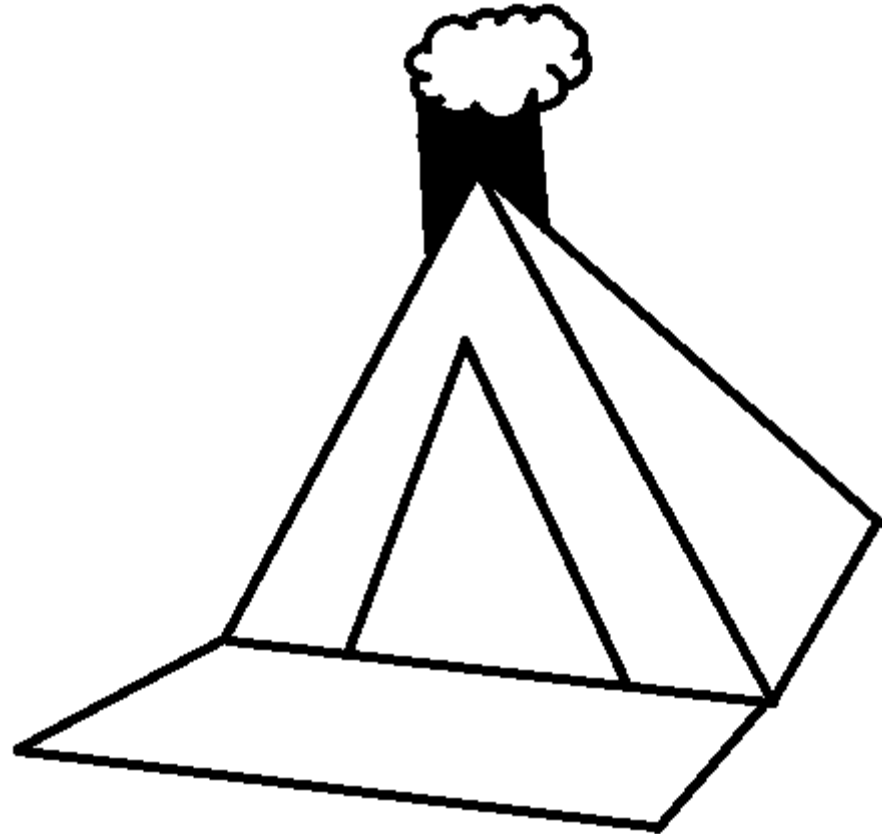

of the building.

They went inside. There were diamonds filled inside the building. There were many rare diamonds. Lucas found a right piece of glass which fit the ship they were making. They went to get out, but when they got outside the part of the floor collapsed. There weren't any way to get out. They were trapped. And they heard a weird sound from inside the glass factory. Lucas was scared. Then, a black shadow came from inside the factory. It was huge. Lucas didn't stay there any longer. He got his

puppy and straight jumped in to the floor that was collapsed. There was a river down there, so they were safe. They swim across the river and they swim to the shore. Well, they got the part that they needed. Then they headed off to the next part, the steering wheel. And it was in some kind of junkyard. So they walked there,

Because the car was in the glass factory,

They got there on 2 minutes. The junkyard was the size of the Mount Everest. Lucas thought they will be never able to find the part that they needed in here. They went inside. There was a shop named “steering wheel” In middle of the junkyard. So, it was a huge relief to Lucas. They went inside. There was no one in that shop. So they began searching for the part that they needed. They searched for an hour. Still, they haven’t found the part that they needed. So, they sit down for a break. When they sit, Lucas accidently hit a button on the floor. This opened a trapdoor to the basement of the shop. They went inside. There were many boxes. So, they began searching on by one. Finally, they found the part that they needed. They grabbed it and left the shop, but, when they were just about to leave the shop. The door was sealed shut. Who could’ve done this? There was no one inside the shop. So, that means someone had closed the shop from the outside. They search another way to get outside. They found a vent that leaves from the shop to

another building. They followed it. Soon the vent ended. It leaved to a

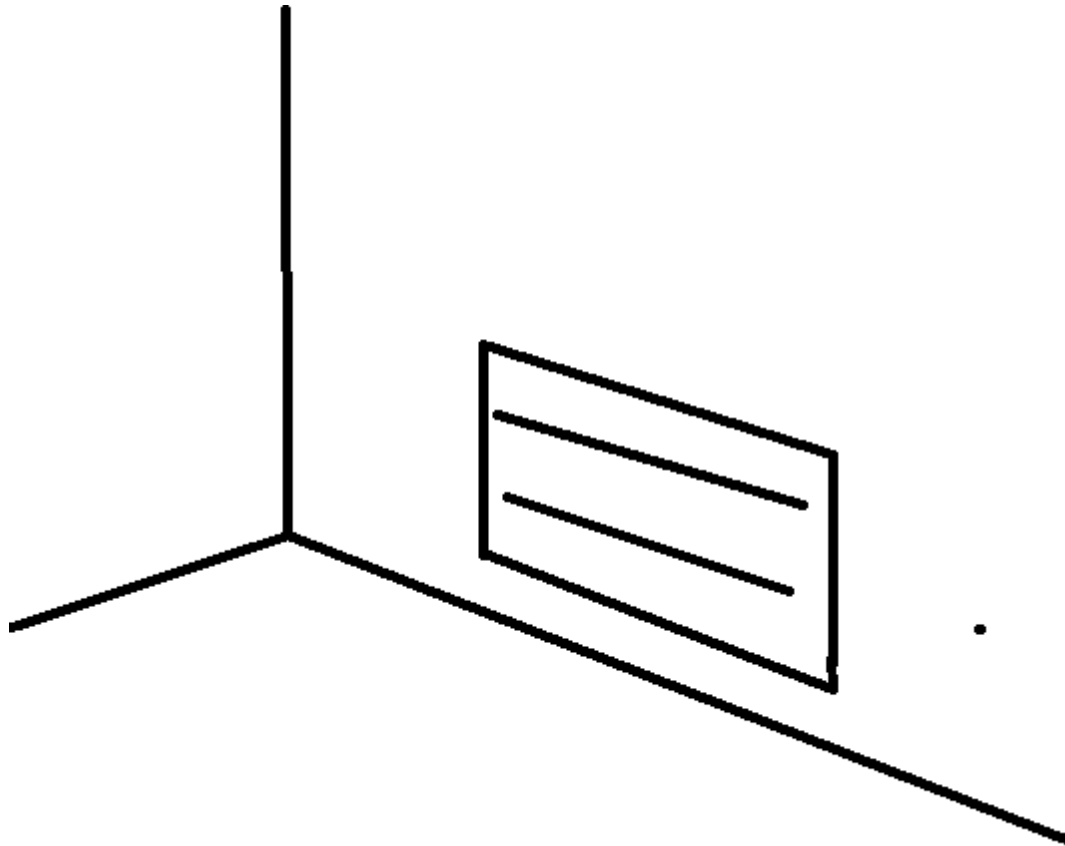

garage.

This was perfect. It was just the place he wanted to go next. There was a shopkeeper there. Lucas asked him if they have a ship engine with them. But, he said there weren't any ship engines here. And the only place they could find a ship engine was the space station. So, Lucas went to the space station with his puppy. It was a massive building. Lucas and his puppy went inside. Lucas asked if there were any ship engines with them. But, they said they are not for sell. Only the ship builders have access to them. Lucas was worried. They got out from the building. But, his puppy said they could get to the building on the night time, on that time station will be closed. They could sneak in to the building and get an engine, and carefully get out. Lucas thought about that idea. They waited until night time arrives. Well, not actually night

time, the planet was tidally locked. Which means one side of the planet was always facing the sun. And the other side of the planet was always facing the distant space. There was a midnight zone between the side that was always facing the sun and the side that was always facing the distant space. The midnight zone was a small line. So, there weren't much space to live in that planet. The alien city was on the midnight zone. The aliens had a time to nap and a time to work. So, Lucas and his puppy waited until the aliens sleep. And when they were sleeping they sneaked in to the building, grabbed the part that they needed, and carefully got out from the building. Then, they ran to the alien park at the speed of the light.

Lucas was happy; soon he was going to get out of this planet. There were only one piece missing, the hardest one to get and the circuit to the ship. That was the alien leader wore as a crown.

Chapter 6

The ship is almost finished. There is only one part that they needed. It was the circuit. Lucas was thinking for days and days for the plan. There were security guards all over that building. However are they going to pass those guards without being caught? Their gear is hi tech, so there weren't many things that they could do for that. So, they saved up that for later and started building the ship. He couldn't do it alone because, he didn't know how to even use that stuff. He needed instructions for that. So, later they sneaked up to the space station again, there they

looked for instructions. They were written in papers so that engineers could study them. They looked and found a locker in the training room. He thought the papers might be inside that locker. They tried to open it but, it was locked tightly. They needed to find the password for the locker. So, there was nothing to do then carry the locker with them. There were bunch of other lockers too. So they wouldn't even notice one locker missing. Without wasting any time, they ran to the park.

They needed to find the password for the locker. So they tried different numbers one by one.

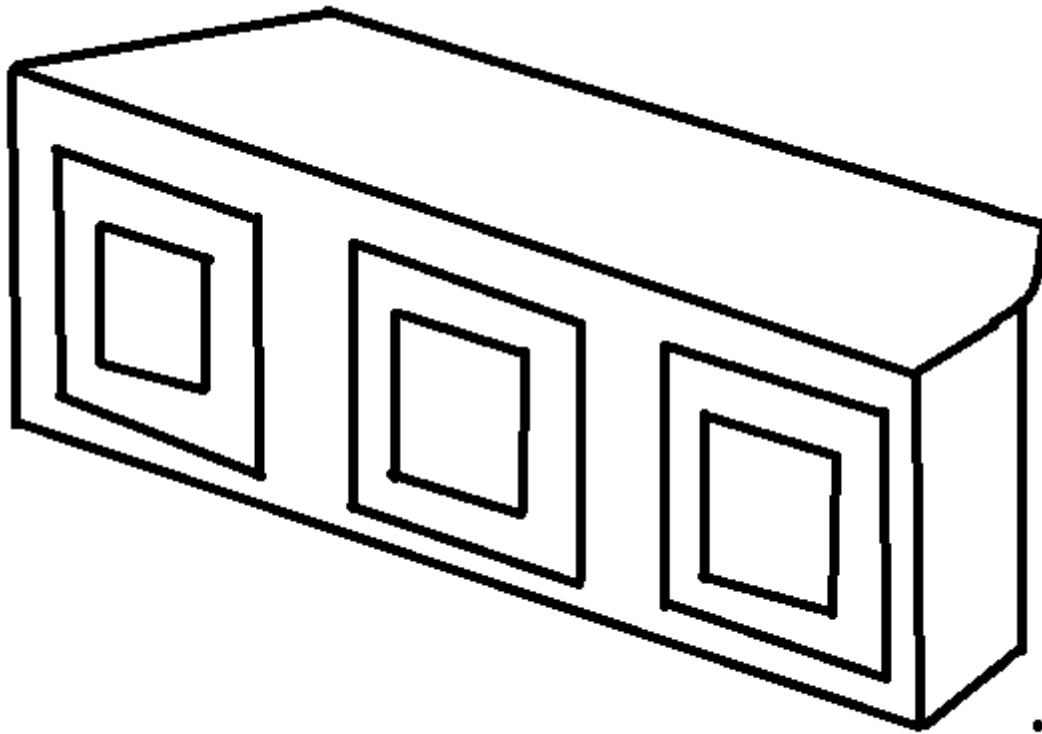

But, it was no use. So they went to the space station, and sneaked on to the training room. They watched the password they were using. And to be amazed, there weren't any passwords. They just had to press the spinning squares. So that was the trick. They went back to the park and

pushed on the spinning squares. It opened. And inside there was the instructions. They had to borrow some machines for a while, so they went to the garage; there Lucas asked if they had those machines. And they said they have those machines. But, they said anyone will only need those machines to build a ship. They were suspicious, so Lucas and his puppy left with the machines before it gets even worse.

When they got there it was about time the aliens would sleep. So, that was the perfect time to get starting to build their ship. It wasn't easy to build it. It took about 5 hours to build the ship. And his puppy helped too. It looked like a normal ship, but there was one piece missing, the most important part and the hardest one to get, the circuit.

Chapter 7

They were making a plan for days. They needed the best plan ever to get the circuit. But at last, they got the plan they needed. There is a party at the leader's building this week. So they could get inside the building by performing an act. While Lucas performs his puppy would carefully get in his throne and grab the circuit. The leader won't notice a thing. By the time they'll noticed they will be gone without a trace to the distant space. It was the best plan ever. And the party will be started at tomorrow. It was perfect.

They headed out there early, the guard let them in. the puppy went inside the leader's throne. The party started. There were many beautiful acts. Lucas was in next. Lucas went to the stage. He sung song that will draw everyone's attention for him. At that second, his puppy

switched the real circuit to a fake one. Lucas ended his song, and got out of the stage quickly. They got out from there as fast as they could and straight went to the park. Lucas connected the circuit to the ship. It was ready to go. They straight got into the ship. The news had spread faster than they thought. Everyone knew that Lucas and his puppy stole the leader's crown and they were already looking all over for them. But, Just when they were about to start the ship, the guards found them. There was nothing to do. Lucas started the ship and straight blasted off in lightning speeds. The guards followed them, but there were nothing to do. But, they were about to leave the atmosphere of the planet. If they fly past the atmosphere they could never catch up to them. But, just when they were about to leave, the engine was stopped by the guards net. The puppy went to fix it. But just when it finished fixing it, the puppy was caught by the guards. It felt to the ground. But, when Lucas was just about to turn over, the puppy said him to go. And he will be returned. Lucas just leaved the planet's atmosphere he blasted off to the distant space. In a short time he will be on the planet earth. But, he was really worried about his friend. It was helping him from the beginning. It was the one who helped him to escape that planet. If it weren't for it, he would've never escaped that planet. He felt sad about that puppy. He was tired too. He turned on the autopilot and napped. In a short time he would be in his planet earth.

Chapter 8

Lucas was awaked. The ship has landed. There were people around him trying to open the ship. His mother was there too. He opened the ship. And he was questioned by many. He told them that he tried to make a

new model of airplanes and it worked. And he went to his house with his mother. Mother asked him where have he been for such a long time. And he told her mother the whole story. His mother was surprised. But, he said not to tell it to anyone. Then he rested for a minute. He still was worried about his puppy. He turned on the television. But, accidently one of his machines was the signal to the television. The channel switched to another channel, it was an alien channel. It said about him and his puppy. The puppy was arrested. And it has been magically disappeared today. Oh yes, he forgot, time goes slower here. And it said they will be headed to earth for a very special meeting. And it held at the same location the park. Lucas knew that his puppy would've sneaked in to the ship. So he went there early and hid behind a tree. He waited until they arrive. And they arrived at midnight. He slowly looked at the ship. The puppy was sneaking from behind. He felt very happy. He went there and hid there with it. Then they ran before they turn on the eraser. They were saved. They went inside their house. His mother wasn't surprised that Lucas brought a dog with him. They both were very happy.

Chapter 9

His dog brought a kind of gem stones that was only found on that planet. That means it's a really rare gem. Lucas did a little research using his computer. Of course, there wouldn't be anything about that gem in his planet. He got the signal for the computer using the machine he made. That allowed him to get access to the alien planet. They said it was a really rare gem, which they knew. And there was only one gem found on their planet. Lucas was shocked. Lucas asked the dog where it found the gem. It said it found the gem on a cave deep below the deep oceans of the Kesus 22-b. so, there was an ocean in the dark side of the planet. It was a secret project. It started at the beginning of this story, back when Lucas just received signal from that mysterious planet. So everything makes sense now. They were secretly planning to conquer the galaxy with that gem, and the water they brought from earth. He needed more information. He needs to stop this before they conquer the galaxy. If they do conquer the galaxy, it all will be over. He needed to get on to that planet once more. He still had the ship he brought. So all they needed to do was sneak on to that planet, go to the dark side of the planet, and discover the caves, and other things weren't planned yet. They needed more information. They said to the mother they will be going on a camp trip. They got outside. They got inside the ship, started the space engine and blasted off to the endless space.

They were able to get out of the planet without being spotted. The only problem was the food his mother gave him. There was no gravity, and his mother gave him the most annoying thing to eat on space, it was bread with a glass of milk. Bread is not a problem at all, but the milk

was. But they couldn't just throw it out because, they were very hungry too. They carefully got the milk and they poured it in to a bag and then made a little hole in the bag, after that they squished the bag so the milk would get inside his mouth, Yeah... very creative. But they were enjoying the milk a little too much; a bit of milk was thrown out to the controlling pad. They tried to stop it before it hit the controlling pad. But it was too late. It hit the controlling pad. The controls were turned off. The ship was floating in space. But just that moment the ship crashed down to a planet, they closed their eyes.

Chapter 10

If you were facing the same situation Lucas and his puppy was facing, I'm pretty sure you will fall into the endless space. And same did happen to them. But, they didn't fall into the dark endless space. When they were falling they were rescued by some aliens in the alien planet. Their ship was taken. The aliens looked friendly. Lucas and his puppy thought they might be arrested. The alien talked to them and asked"

what are you doing in this planet?” they said they accidentally flied over to the planet. The aliens got them something to eat. Lucas asked” aren’t you going to arrest us?” the aliens said “how could we arrest you when you never even been on this planet?” Lucas was confused, he looked outside the mirror, and they were shocked. They were in another planet. They got outside; they needed to get to that another alien planet before it was too late. They asked the aliens for help. They explained the whole situation to them. The aliens were shocked. They were glad to help them, they gave them another improved ship and some gear and weapons. They felt much safer now. The weapons were a freezer gun and a teleportation gun. Those were the most improved guns in the whole galaxy.

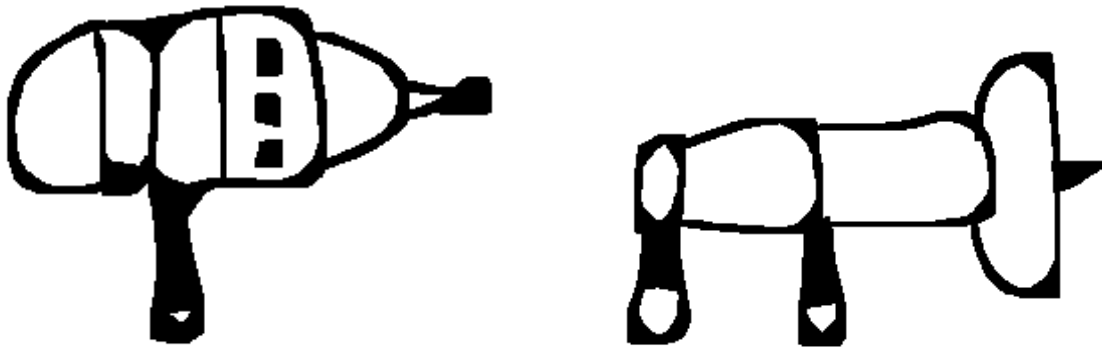

They headed off to the ship the aliens gave them; it was a much safer and a more geared one. They said goodbye to the aliens, and blasted off. They were happy to make happy alien friends with them. Now they have a whole new alien planet to get help from. The ship had a navigation system which helped them to understand where they were, and not to land on another alien planet. Who knows what kind of aliens lurks out there in the darkness. There could be happy aliens like they just met or there could be much unfriendly aliens like they met before.

However they were making much more progress than they ever made. The navigation told them they would be on the alien planet about in 10-15 minutes. On their way they met an alien café and an alien mine. They didn't bring any tea or coffee from the alien café because they remembered what happened before. They took a shortcut though a wormhole. It was much safer and much faster. They took that shortcut because who knows what could be going on that alien planet. It could've been worse if Lucas and his dog didn't found out that they were up to something that is not good. By no good I mean something that would destroy the whole universe. It was nice that they found the wormhole.

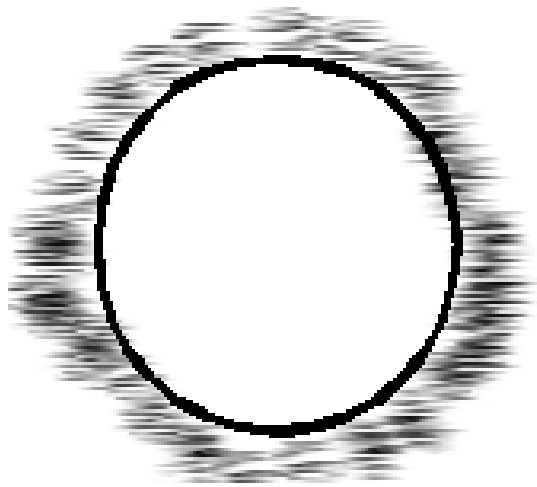

Meanwhile on the alien planet, in the dark side of the planet, the hunt for the rare gem stones was secretly making much progress. In their dark side of the planet the gems weren't that much rare. They already found tons of it. And they were also bringing much water to their planet. By, activating a little machine that could bring water from another planet and that another planet was earth. The machines were all over the planet. In the deep seas, oceans, lakes, rivers they were all over. The planet was slowly but surely running out of water. Lucas and

his puppy needed to do something quickly. If they don't it will be the end of the whole galaxy.

Chapter 11

Lucas was able to get in the alien planet with his puppy in 10 minutes. The alien planet looked normal but it was on the midnight zone of the planet. The planet was tidally locked. They landed in the midnight zone of the planet without noticing. They landed in the place they mend a ship, the park of the alien planet. Everything was normal there, aliens walking by without even noticing, the yellowish sky without any clouds, posters of Lucas and his puppy all over the place. Yeah, Lucas and his puppy were wanted by the aliens on the alien planet because they escaped that planet without any permission from the aliens. And they were a little angry about that.

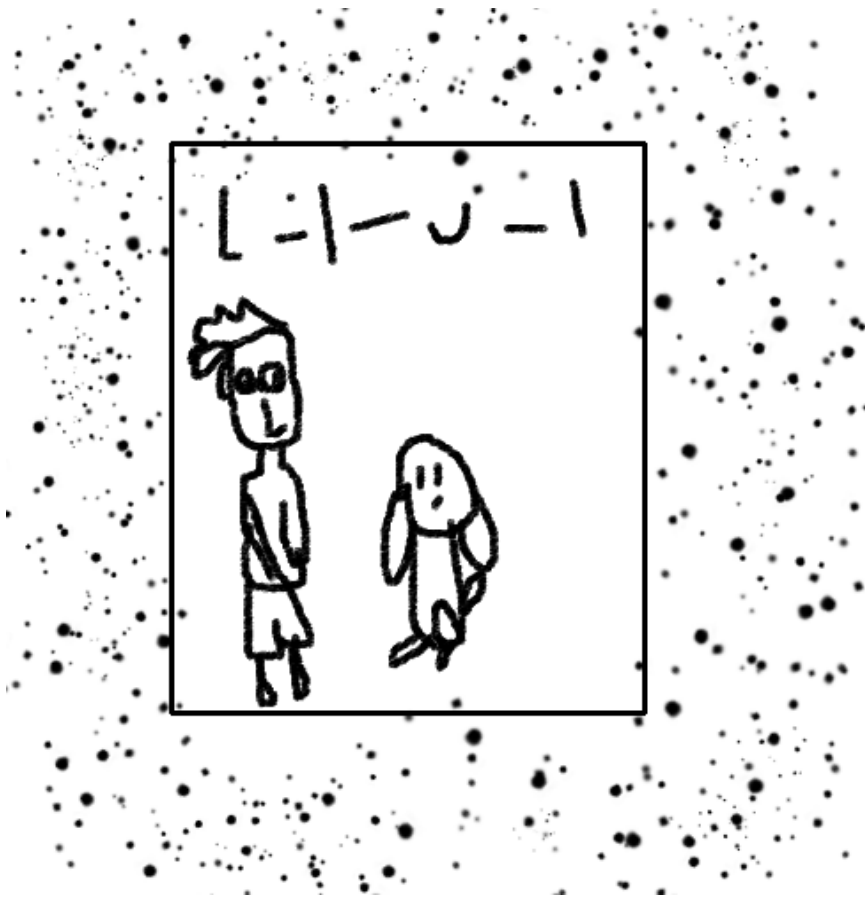

The aliens were terrible drawers. As you can see, they weren't much good at drawing stuff. (I highly recommend for ones that have weak stomach to look away from this picture fast as possible. If not, I'm not going to pay the hospital bill for anyone) and this wasn't a drawing that looked liked it was drawn by a pro. Okay, to the story again. Lucas and his puppy got to the dark side of the planet by walking. It wasn't very tough, as you might think. The aliens were only in the midnight zone of the planet, unless if you were not counting the amount of aliens working in the secret project. They got to the dark side of the planet in minutes. The dark side of the planet was a dark, inhabited, lifeless place. And worse of all, they forgot to bring a flash light with them.

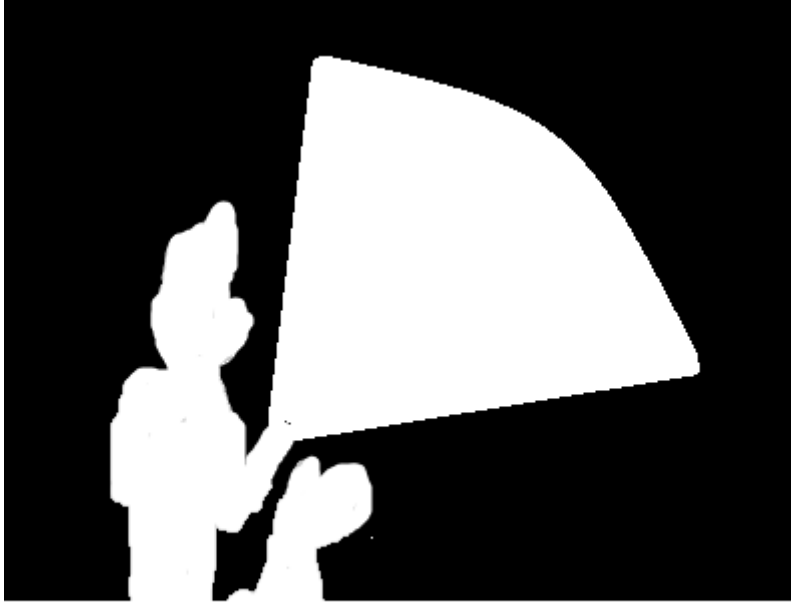

About that they got the flash light from the gun that the friendly aliens gave them, its aim was enough to light their way up. They haven't tested them up yet. But without wasting any time they began searching any clues for where the caves might be, they searched and searched, but at last they got nothing. They supposed that they could get to the midnight zone of the planet and start searching for any information there, with disguises of course.

So they sneaked up to the midnight zone of the planet to search for any information. They disguised as aliens and pretended that they are very fine. First they got in an alien library and began searching. They read books about the rare gem. They weren't finding much information but they found a few. The gem was never found on their planet for even ones. But the books say, some have found them but they have hidden them for safety, because they were deadly and explosive for their

reactions. The book says, someone had found one of the gems and found a perfect reaction to destroy the whole galaxy. The founder was never found, and so as the gem. His puppy found out that information. Who knew puppies could read books?



The writer of the book was someone named “railer”. They asked the librarian about the author. He said that he lived in the central park of the alien city. So, Lucas and his puppy went there to find him. And they found him in the pond of the alien park. He lied down the trees. He was very old indeed; they asked him about the gem. He said it was the brightest gem he had ever seen. They asked if he had ever seen it somewhere. And he said that he seen it in the dark side of the planet. They took the old alien grandpa to their secret hideout, and reviled their true selves. The grandpa was shocked; they told him everything they knew. The grandpa understood. He saw this project in his life before. He found it when he was very young. There wasn’t anything he could do. And he said now they must be closed to their target. He carefully gave them the most precious thing in his life, a black diamond.

It was the rare gem that they were finding about. Lucas took the both gem pieces his puppy gave him and the old grandpa gave him. When he hung both gems together closely, the gems merged in to a more shiner and a new one. They put the gem into a water pot. And then the whole thing exploded. All that was left was the ash from the pot and the gem. And then the ash melted through the ground to the core of the planet. They were surprised. The ash was deadly enough to melt through anything. They needed to do some research about the ash.

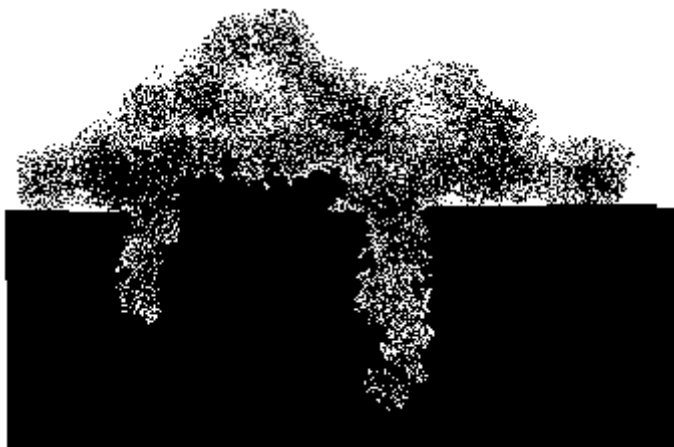

This could be what the alien trying to do. This ash is strong enough to destroy the whole planet. Lucas was able to stick the ash in the ice, using the freezer gun. It was the only thing it weren't reacting to.

Chapter 12

Back in the dark side of the alien planet Kesus 22-b there was this mine deep below the seas only the alien leader and his works know where it was, what were they doing, all the others doesn't know anything about it. They were slowly making much more progress, our heroes Lucas and his puppy didn't even know where this mine was. The aliens were using that gem for something very-very evil. They were using the ash of the

water and the gem combined together to make a secret potion that will turn any living thing in to a fearless, mad, untouchable beasts. Lucas and his puppy still didn't know this. They are still doing some research about the ash they found. The aliens have already dug the mine nearly half way through the seas of the dark side. Lucas and his puppy must do something now. Or this little mine will turn the whole galaxy into a lifeless place.

Lucas was confused. He hadn't found anything good yet. His puppy was eating bones. He thought that he might need some more information. So they brought a flashlight and dived though the seas of the dark side. They searched everywhere for some clues. They haven't found anything good yet. The seas of the dark side is no little place for searching, it spreads around 5 times or more size of the alien city. The oceans were rich in oxygen and mostly alien sea plants. But they found a place where it was hard to breath. Lucas turned on his machine and searched what was making it hard to breathe. And there was this liquid that was leaking by some kind of a rock. It was making it hard to breathe. It was lowering the oxygen levels. Lucas packed that liquid in to his freezer bag and left the oceans. He returned to their secret hideout and showed the alien grandpa what he found. He asked the alien grandpa if he knows anything about this liquid, but he had no idea.



Lucas and his puppy had hard times in this alien planet, first they tried to get out of the planet and they successfully did get out of that alien planet, but now they are trying to save the alien planet and the whole galaxy. They analyzed the liquid they found on the dark side oceans. The liquid was a very black one. And also it was lowering the oxygen levels and it was making it hard to breathe. The old alien grandpa was very old to tell anything. In the night time they were going to go to the dark side of the planet once again. They firstly swam into the place they found the strange liquid. But, they didn't even found a bit of that liquid flowing in the nearby waters. They tried to find some more information about the liquid they found. They tried to search some more information in the deep caves of the ocean. Lucas was very small for the big caves down there. They needed to split and go to different caves. From that way they could easily find some information about the liquid. Lucas went to the deepest caves; it was getting darker and

darker Lucas turn his flashlight much brighter. Lucas search every inch of the cave. But, he didn't get anything. But, just when he was about to give up Lucas found another small entrance in the end of the cave. Lucas squeezed through the small gap and what they found was totally mind blowing. It was the source of the whole liquid. It was huge black diamond.

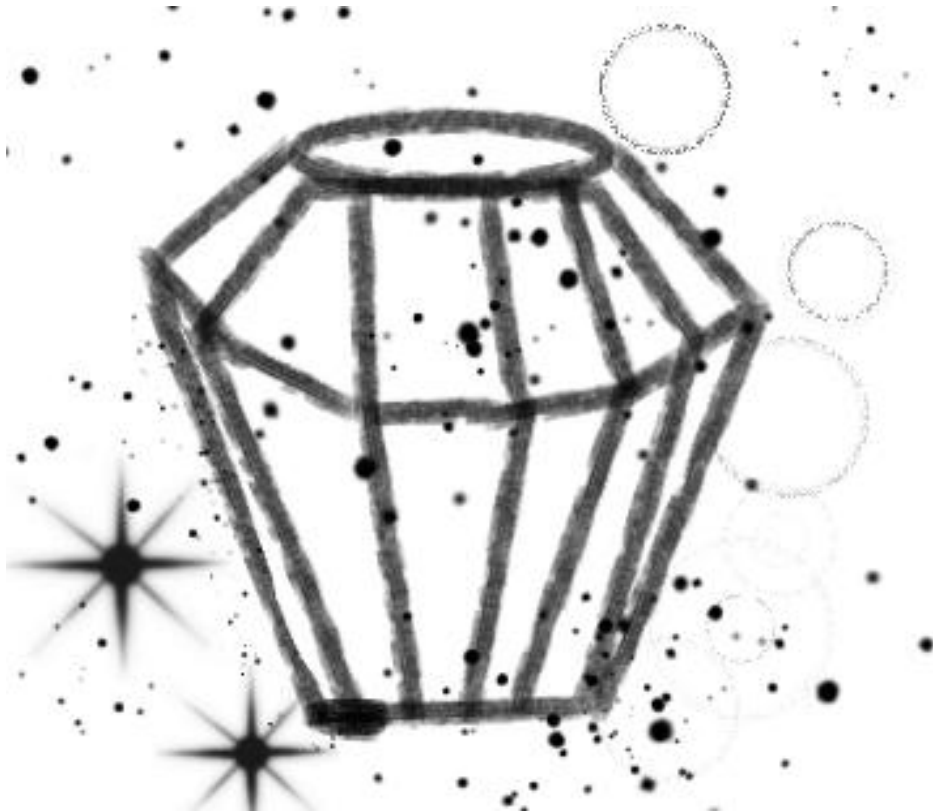

Lucas was shocked. he took the diamond. It was making that liquid. It releases a kind of liquid that when it's mixed with water they turned in to that liquid. He quickly swam back to the surface with his puppy. Then they ran to their secret hideout.

They hid the gem in a safe place. They now have many questions, but when they found that gem everything make sense. They were using the

liquid that flows from the black diamond to make weapons; they were using the ash from the other gemstones to make weapons too. Both gems aren't the same. They were different kinds. The aliens were planning to make weapons with these gem kinds. They needed to stop them before they destroy everything.

Chapter 13

Lucas went to sleep early that day they found the huge diamond. Lucas was worried that something bad might happen to them. After all, they were taking a risk that no one would take. Their story will be talked all around the galaxy. They thought that these aliens might be their best friends because they'll save the whole galaxy. But who knows what could happen. Lucas went to bed; he took out a book and read it until him falls asleep. He read the book for 2 minutes when suddenly a piece of paper fell from the book. He picked it up and read it. And he was shocked.



It was map to another island. There were two main islands. One was named aero island and the other was named Ball Island. But on the map there was an island named "B.D". Lucas got off the bed that instant, and he put the map into his bag.

Lucas went to get his best buddy. He told him everything. They planned to go to the island that night. After all, it was a very important mission.

They were getting closer and closer to solving this mystery. Whatever it is, they would have to get ready to face anything that stays in front of their way.

Lucas and his puppy went outside. They carried the map and the gem they found with them. They were in Ball Island so they needed to get to the aero island first because; the mystery island was closer to the aero island than ball island. They needed to get there without being spotted. They go to the closest beach nearby. There weren't aliens out their looking for them so they were free. They gathered some wood and started building a raft. This is the only way they could reach the aero island. Because they weren't able to swim and also they couldn't make any contact with the other aliens out there. They build the raft just in time before some alien spotted them. They added an alien ship engine to the raft so that way they would be able to move faster. Lucas thought that they would take an approximate 2days time to get there. They moved fast as they could.

On this planet you might remember that there was free food, but without any contact with the aliens, they had to cook their own meals. But the problem was that there weren't many fruits like here on earth. Some fruits were safe to eat and some others were poisonous. They needed safe things to eat, and that moment Lucas remembered that there were many fishes under the waters like here on earth. Well, not like here on earth, what he means by fishes is the fruits that grow in the oceans of the alien planet. He remembered that they were the best fruit in the whole galaxy. Could you imagine him fishing in middle of the

ocean? All he'd get is a socked boot of an alien pirate.



Lucas picks up some fishes and shares it with his puppy. They were half across their journey. They were having much fun along the way. And they also planned how to locate this mystery island. And also the name of the mystery island was also suspicious. It sounds like there is something very bad going up there.

Anyway, they reached the aero island about in 1 day. But they still have to travel a long way to the mystery island. They gathered more things that they'll need for their journey without being spotted. They wondered how this journey could get any worse.

Chapter 14

The main plan was to gather supplies from the aero island and head straight to the mystery island without stopping. But, they had to stop on the aero island for a while because of a strong storm. And it not any storm, it's the strongest storm in the whole galaxy. They just had to stop. But, Lucas didn't care about that, neither did his puppy. They got their supplies and got to their raft and make the raft a waterproof and make a small shelter in the raft for them. And they got into the raft and started the engines and they raced to the mystery island.

The journey wasn't easy as they thought the wind picked a strong speed. They went inside the shelter. They were safe there. They thought this was the end for them and they went to sleep.

The tides of the oceans raised, the small raft couldn't just handle the big waves. The storm grew, the raft broke to parts. Lucas and his puppy were nowhere to be seen. Lucas and his puppy were no longer remembered where they were or what they were doing. That is because of the storm. They both lost their memory because of the water that got into their head.

Lucas woke up, he slowly remembered everything. He was on an island. He looked around. His puppy wasn't there. He started looking for him. But there wasn't any sign of him anywhere.



The island itself was very beautiful. And there was huge shiny tree in top of the mountain. It looks like it was a magical tree. But he was very sad because his puppy wasn't there with him.

Lucas looked around to find someone. Since this island was hidden from the whole alien world. And then he remembered that he was on the mystery island, and also because there weren't any other islands. He rushed to a bush and hid fast as he could. But there weren't anyone around him. But he was scared because his puppy wasn't there with him. So he slowly walked into the forest without anyone noticing. Well, there weren't anyone in this island at all. But he decided to walk to the very middle of this island, to the magical tree on top of the island.

He walked and walked for hours. He started get hungry. He began searching for something to eat. He found some apple like fruits that

was pink in color. It was a bit suspicious that it was pink in color. But due to his hunger, he ate without any second thought. And guess what had happened? The pink apple was poisonous, his body started to shrink, he felt like he was an ant. Everything was huge to him. He couldn't believe what he had eaten. He thought that he might never be his original size again. But just as he thought that, pink apples fall to the ground in slow motion. Everything was going in slow motion because he was very small. He rushed under a tree, he was safe there. And after that he began to walk again.

He was very tired because he was very small, and it took a long time for him to walk. If he was his original size he would've already make it to the mountain top. He felt sleepy. He tried to get some sleep under a tree, but just when he fell asleep, someone was coming in his direction. He hid as fast as he could. When that somebody came in he realized that it was his puppy. He felt happy. He jumped to his head from the treetop. Then Lucas yelled at the puppy's ear. Puppy realized that Lucas was in his head. But just that second Lucas grew to his regular size. He and his puppy were very happy that they met each other again.

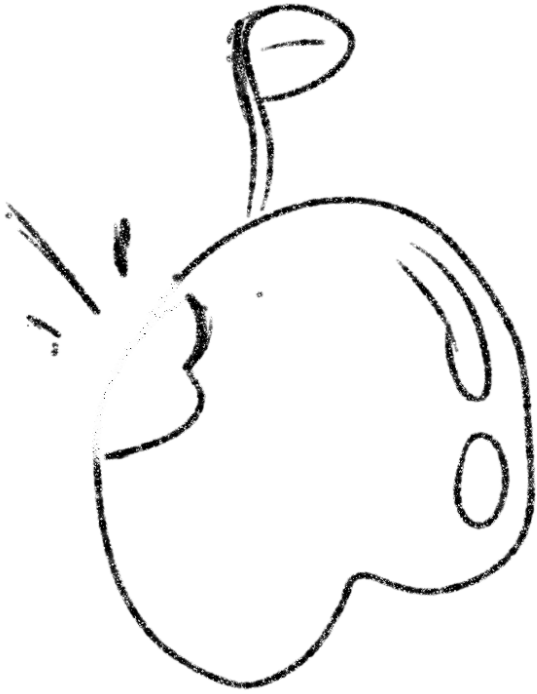

Chapter 15

Lucas's puppy showed him the other side of the island, it was a lifeless place. Lucas was surprised. One side of the island was beautiful and the other side of the island was lifeless. Lucas thought that there might be something to do with that under the grounds of this island. They thought of going there from the ocean. But before that they explored the magical tree in top of the island. They climbed to the top of the mountain again. The tree was very shiny. It had golden colored leaves and it was bigger than all the other trees in the island. They looked around the tree. There were many fruits in the ground. They were also golden colored. And there were also statues of animals that were also golden colored. Lucas collected some golden fruits in to his bag. But he didn't eat any of those. He remembered the last thing that happened to

him when he ate a suspicious colored fruit. They were also getting tired by all this walking and climbing. So they decided to rest for a few minutes.

Lucas and his puppy were in asleep. The island began to shake. Suddenly, a trapdoor opened from the caves. There were many aliens wearing gas masks. Lucas was awakened by the large sounds. He saw the aliens and he watched carefully what they were doing there. They were carrying a gem each to the caves. And the gems were black diamonds. Just like the one Lucas had. He was shocked. The aliens got into the caves and disappeared. Lucas woke up his puppy. Lucas told him that they will go there and find out what was going on, and what was they were doing with the gems. They hurried down to the caves. They watched as the aliens climb down the ladder, they all climbed down the ladder.

They were going to climb down the ladder when all the aliens were gone. In about five minutes they were all gone. Lucas and his puppy slowly climbed down the ladder. It led to huge have system down below. And all the caves led to a one big cave. All the aliens were there. They knew about that from the map. It was right beside the ladder. They carefully walked. There were aliens everywhere. They were able to get to the main cave in minutes. And they were surprised to see what there was. They were shocked. There was a massive portal just inside the cave. And they were powering the portal with black gems. Lucas understands everything now. They hurry to hide. All the aliens were brought here for some reason. The alien leader was there too.

“Dear aliens, now we are ready to conquer the planet earth. It’s located in the Milky Way galaxy. Because it’s way too far from here,

we've built a portal from here straight into the planet earth. We'll conquer that planet and using water we will make the strongest weapon in the whole galaxy. We just need the black diamonds and the water from earth."

Everything makes sense now. They had to stop the aliens from getting there through the portal, before it was too late. Lucas knew that the black diamond's power the whole portal. So all they needed to do was cut the power supply from the gems. Lucas ran to the power generator and just when he was about to turn it off. He was caught in a cage. The aliens knew that he was here. The alien leader told him "we always knew you were here son. So prepare to see your planet being exploded to pieces." Lucas was angry. But there weren't anything that he could do. The aliens got through the portal to earth. Lucas thought that everything was over.

Chapter 16

Lucas was sad. If he had turned off that generator in time, nothing would happen. But now everything is over. Lucas's puppy came in and freed Lucas. Lucas was sad. He walked away with a sad face. But just then he remembered the dust of the diamonds. When they mix with water they explode. And the aliens were also running their ships with water and also the weapons that they made were running with water. And also the portal was made with water and black diamonds. He got a plan. He ran to the portal and set a bomb. It would explode when he push the button in the controller he had. So, when the aliens are all

gone thought the portal thought to the aliens' planet the bomb would explode and the portal would be destroyed. Lucas and his puppy ran thought the portal with hope.

They were in planet earth in no time. The aliens had conquered the planet. But Lucas had a plan. He rushes thought the roads to the headquarters of the aliens. He carefully sneaks to the alien leader room. The generator for all the ships were there, he putted a bomb in there too. Then he ran towards the roads. All the cities and everything here were destroyed by aliens. He ran in front of the aliens and showed himself to the aliens.

The aliens said" sorry kid. But we have destroyed everything on this planet before you knew it. There's nothing you could do". But Lucas wasn't scared he waited until the aliens shot him with their weapons. The aliens were mad; they aimed at the boy and shoot. Just when they shoot he pressed the button. Every bomb exploded including the one on the alien planet. The ships exploded the portal sucked all the things the aliens brought here, and then the portal exploded.

Lucas stayed in front of the explosion like hero. Who was a hero? He looked like superman with his puppy. Lucas and his puppy were very happy. Their plan worked. The earth was safe. But it would take few more years to repair what they had done.

Chapter 17

5 years later.....

Lucas was sleeping. His mother calls him. He goes to her with his puppy. His mother talks with him every morning about the explosion happened 5 years ago. Nobody knew there were aliens or Lucas saved the world from them, and also his puppy. Lucas act like normal. But even if nobody knew, he was the real hero of the galaxy.

The end

Afterword

As modern technology permeates the social and economic arenas, students tend to distance themselves from the creative process, relying more and more on technological tools. To reduce this risk and help aspiring young writers produce their own books, I sought and presented a research proposal to the Ministry of Education in 2014. It was a fantastic opportunity for children to showcase their enthusiasm and knowledge. The students of Mahamaya Girls' College achieved a record for the most books written, paving the way for a new level of innovation.

The e-book project will enable the students to reach international readers, and I am confident that they have gained new experiences and challenges that will enable them to face the future with resolve.

I wish all of the young writers the best of luck in their future endeavors

Senevirathna Mahalekm

Founder of Books Publishing Project Among School Children

2023 10 20

About the author

I'm just a kid that is 13 years old. This is a little story I wrote. My name is Diniru sithmira. This is not my first book. I've published many books in the past. They are available for you to purchase at book stores. But, this story is the best story I've ever written. And there are some things that space lovers might like read about. I hope you enjoy the story.

A handwritten signature in black ink, appearing to read 'J.m. Sithmira'. The signature is stylized with a large initial 'J' and 'S'.

J.m. Sithmira

A student of v.c.k